



# Alumatec Pacific Products

1155 West 500 North  
Centerville, UT 84014  
TF: 877-770-0181  
Fax: 801-298-0905  
Email: [info@alumatecpp.com](mailto:info@alumatecpp.com)

## GRILLE TAKE-OFF & FIELD MEASUREMENT

Customer: \_\_\_\_\_

Job Name: \_\_\_\_\_

City / State (*jobsite location*): \_\_\_\_\_

### STEP #1

#### Mounting Options

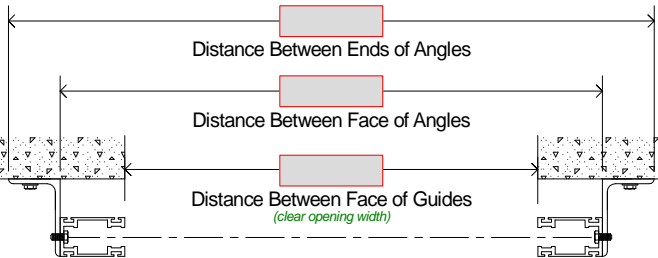
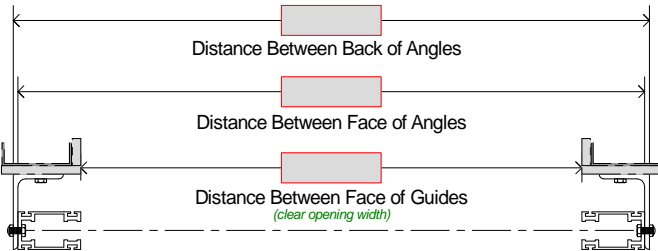
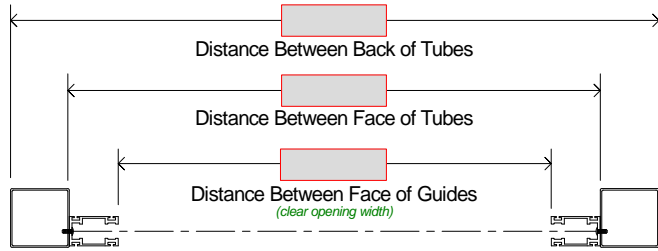

### (A)

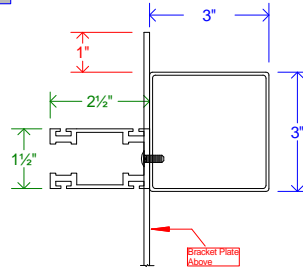

### (B)

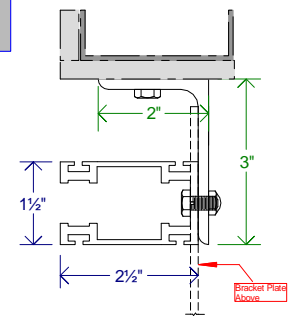

### (C)

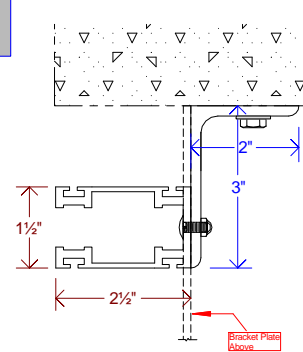

### STEP #2

#### Coil side (interior / exterior)

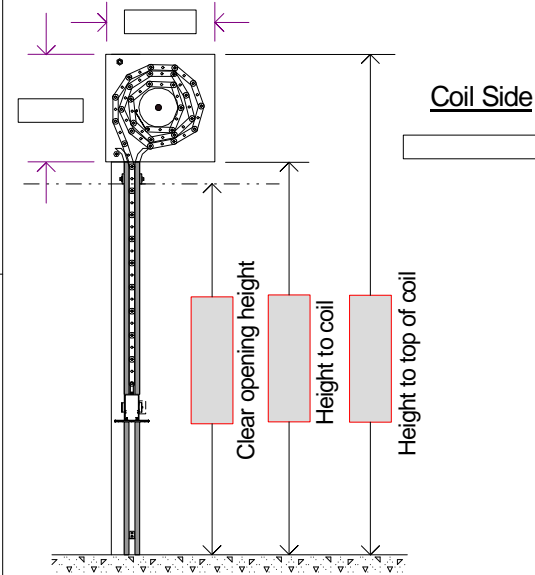

### STEP #2a

#### Motor Option

##### Jackshaft

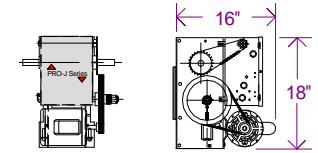

##### Hoist Jackshaft

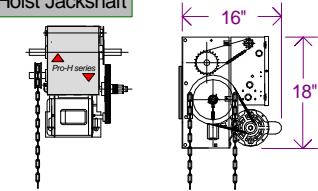

##### Gear Head

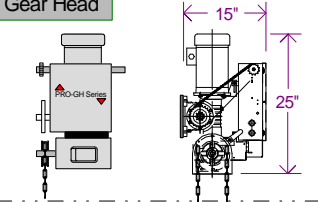

### STEP #3

Keyed cylinder

Thumb-turn

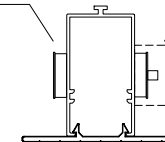

### STEP #4

Model: \_\_\_\_\_  
 Lock cylinder: \_\_\_\_\_  
 Cycle-Life: \_\_\_\_\_  
 Hood Cover: \_\_\_\_\_  
 Hood Material: \_\_\_\_\_  
 Supports: (mount A,B,C)

Curtain Finish: \_\_\_\_\_  
 Bottom Bar Finish: \_\_\_\_\_  
 Cap Finish: \_\_\_\_\_  
 Guide Finish: \_\_\_\_\_  
 RAL #: \_\_\_\_\_  
 Additional Notes: \_\_\_\_\_

### STEP #5

Operation: \_\_\_\_\_  
 Drive Hand: \_\_\_\_\_  
 \*Motor: (if required)  
 \*Motor Model: \_\_\_\_\_  
 \*Power requirement: \_\_\_\_\_  
 \*Prep for motor by others  
 \*Interlocks: \_\_\_\_\_

### STEP #6