



Alumatec Pacific Products

905 North Main Street, Unit D-1

North Salt Lake, UT 84054

Phone: 801-298-0181

Fax: 801-298-0905

Email: info@alumatecpp.com

Installation Instructions for Alumatec Pacific Products Sliding Grille Models: ST-12, Glazed (Lexan) Slider, Perforated Slider, Solid Slider

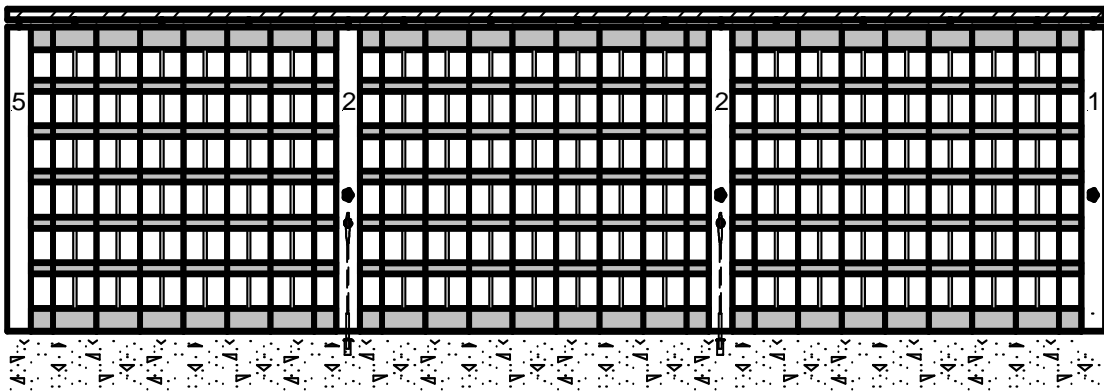

IMPORTANT

1. These instructions are to be read in conjunction with the accompanying drawing(s) for specific slider to be installed.
2. Before commencing installations of any Alumatec Pacific Product, it is necessary to take final site measurements to ensure and verify that the grille can be properly installed. Check the opening height and width and compare those measurements to the drawing(s) provided with the gate to confirm that they are identical. If they are not, STOP, and notify Alumatec Pacific products immediately to determine course of action. Do not proceed without direction.
3. Inspect the bulkhead carefully to ensure the wood blocking or structural support provided for track attachment will be sufficient to support the grille weight. Structural support must run the entire length of the opening. It is extremely important to verify the support in the stacking area(s) of the curtain(s), as this is the point of greatest stress to the support provided on the day-to-day operation of the grille.

Suggested Conditions for Track Mounting

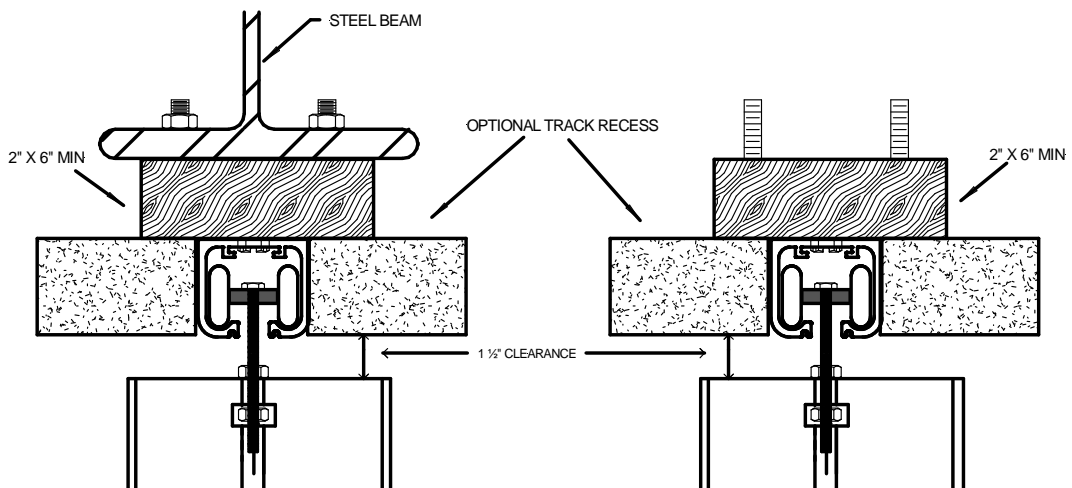

General Steps for Installation

Part 1 – Install Overhead Track

STEP 1. Install track curves (if applicable) or straight track at the pocket first. Maintain clearance the folded curtain by measuring at least 4" from the centerline of the track to any point around the track. (see illustration)

Step 1

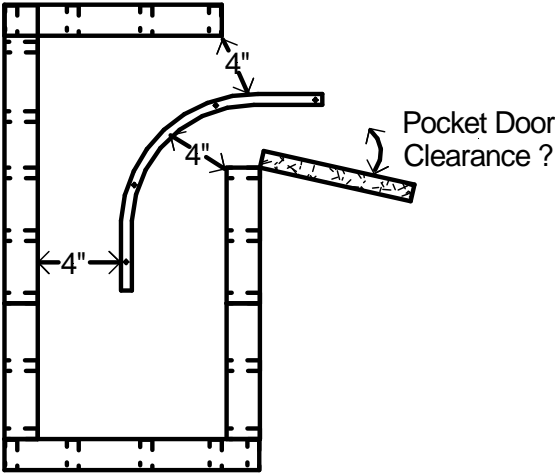

STEP 2. Working outward from the pocket, begin installing subsequent portions of the track. Chalk lines are helpful to align straight portions of track. It is advised that you file the edges of each track section to de-burr. Field cuts must be straight. Leave off one straight section for curtain loading.

Step 2

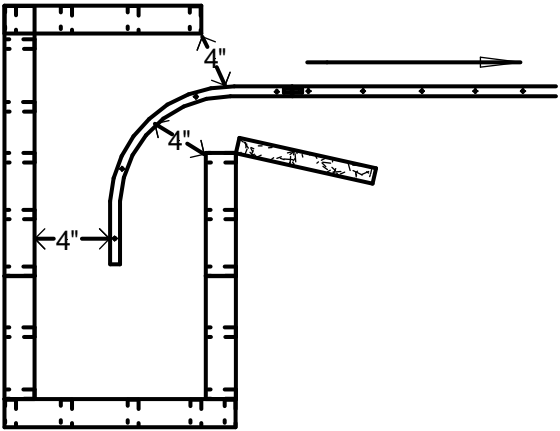

STEP 3. Complete installation of track in pocket prior to loading curtain. Maintain clearances for stacking. Additional screws may be necessary to carry extra load of stacked curtain in this area.

Step 3

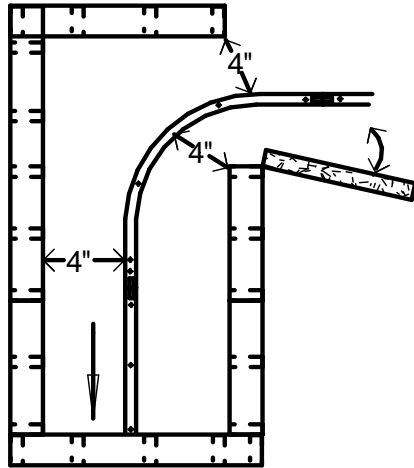

Attaching Consecutive Pieces of Track

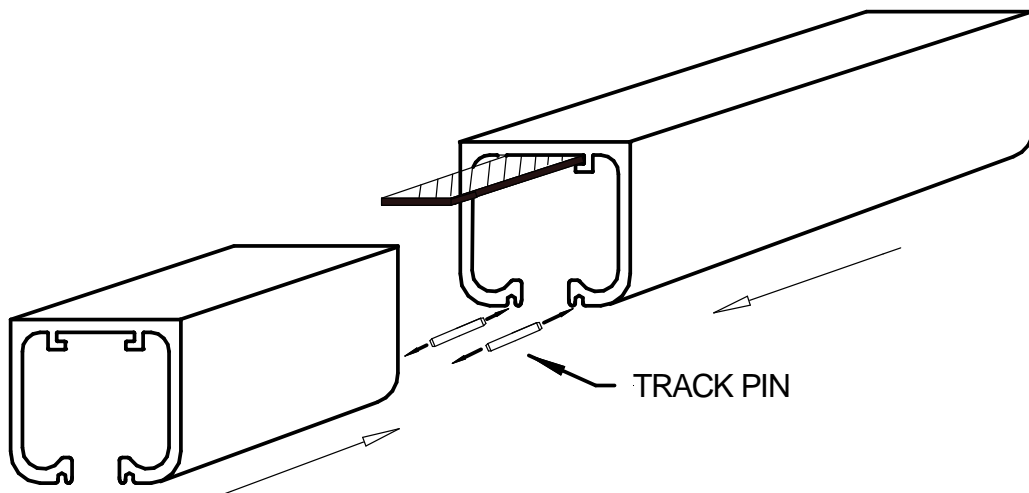

Part 2 – Loading the Curtain

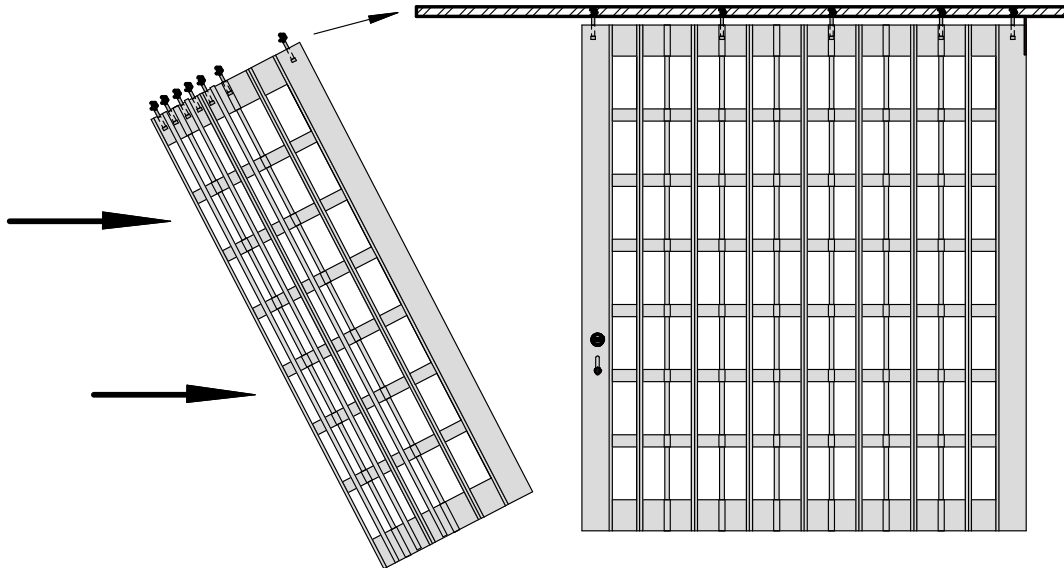

***** Do not attach lock posts together at this time. Attachment to be done after all sections of curtain is hanging in track.**

STEP 1. While resting the bottom of the grille on the floor, feed the posts and curtain sections into the straight portion of the track that was left uncompleted. Load curtain according to the order on the accompanying drawing(s). Note post type and cylinder position for proper orientation. Pre-drilled connection holes are located at the tops and bottoms of each post.

STEP 2. Connect locking posts by “snapping” the extrusions together, aligning the predrilled holes, and securing with the 1/8” rivets provided.

STEP 3. Now complete track installation. Be sure to check all joints for proper alignment and verify all connecting pins and plates are installed. Roll curtain past all track joints to ensure smooth operation.

STEP 4. Stretch the assembled curtain across the opening, positioning the trailing end post as deeply into the pocket as possible without tensioning grille(DOOR SHOULD BE SNUG, BUT NOT TIGHT). Install the V-Stop with the closed end directly below the bottom stop bar (attached to the trailing post). Flare the open end of the V-Stop to span the pocket width. Adjust the bottom stop bar by loosening the screws to the back of the post and allowing the bar to drop downward until it catches the V-Stop, but before it touches the floor.

* If attaching a fixed end post, attach extrusion plate to the wall then “snap” post into plate, align pre-drilled holes, and secure with 1/8” rivets provided. (similar to post to curtain attachment) Skip step 6.

STEP 5. Push the door into the pocket and attach the ceiling stop angle directly above the closed end of the V-Stop. On the side of the track that is above the stop latch on the top of one side of the trailing edge. Loosen the trailing edge ceiling stop bar screws and push upward to catch the stop angle below the ceiling line. When the curtain is pulled across the opening, the trailing post should catch at the top and bottom stops, while still allowing the rest of the curtain to pass freely in the track.

STEP 6. Stretch curtain completely across opening until trailing edge had caught and the leading edge is at the opposite wall. Choose the conditions that apply:

- Solid Wall. Align wall strike plate with curtain and track above. Using a level, make sure the post is plumb. Attach wall strike to wall using pre-drilled holes. Drill a 3/8" hole approximately 1" deep to allow lock pin to join strike bar in proper alignment. Lock post to verify alignment.
- Floating Post. Place a level on the leading edge of the post to ensure post is plumb. Move bottom lock lever down until lock rod touches the floor. Mark the spot, release lock, and drill straight down approximately 3" with appropriate drill bit for the floor or counter material. Clean hole and insert floor duster. Move post back into position and engage bottom lock. Leveling the post again, push the top lock up firmly until it hits the inside of the track. Repeat several times to leave a clear mark. Unlock post, pull away, and drill 1/2" hole straight upward at the mark left on the inside of the track into the support. Carefully clear any debris from the track.

STEP 7. Lock lead post and position all posts to that the curtain is evenly distributed in the opening, making sure the curtain is not over tensioned. Move the lock knobs on each intermediate post downward until the lock rods hit the floor. Mark all spots. Unlock curtain and push into pocket. Drill all spots straight down about 3", clean holes, and insert floor dusters.

Upon completion of installation, open and close curtain several times to ensure the rollers operate freely, that the trailing post is secure, and that all locks operate properly. It is advised that the owner or project superintendent sign for keys.

STEP 8. Apply a non-oil based lubricant (Silicone Lube) in the track and roller bearing to helps with the ease of operation. We do recommend that the door is lubricated once per year as a routine maintainance.

Instructions for Drilling Floors and Counters

A masonry bit of 3/4" diameter is required for drilling into concrete or tile. A good coring bit is highly recommended for drilling through marble, granite, or tile. Remember that if any voids under the tile are present, the tile will likely break. Tile glue and grout should harden for at least 24 hours prior to any drilling. (Always check with contractor before drilling any holes.)

When drilling through carpet, cut around your spot, remove the piece of carpet cut, so that you are drilling into the bare floor underneath. Make sure that no carpet threads wind around the drill bit. A slight over cut will be covered by the floor duster flange that is 1 1/4" round.

END OF INSTRUCTIONS